

## USER MANUAL

### Ultralux DMX512 decoder – DMXRGB24

#### Product Introduction

DMX512 decoder is the constant voltage decoder, can accept the international widely-used DMX512 standard digital control signal, convert it into PWM signal to actuate LED RGB lighting; suitable for all kinds of constant voltage LED lamps, such as RGB LED module, LED strip, light string and so on; Decoders can be connected with signal line through network port or XLR plug to continue expanding the channel, and accept the manual-setting address by DIP switch, control different multiple decoders lighting effects through the DMX console; **When the decoder is not connected with the DMX console, the machine can be set as master controller by DIP code, and multiple decoders can be sync-work.**

#### Technical Parameters

Working temperature:  $-20\text{ }^{\circ}\text{C} \div +60\text{ }^{\circ}\text{C}$

Output: 3 channels

Max. Output current: 3x8 A

Supply voltage: DC12V $\div$ 24V

Output power: 12V -  $\leq$ 288W,  
24V -  $\leq$ 576W

Static power consumption:  $<1\text{W}$

Connecting mode: common anode

Transmit signal: DMX signal

Power off memory: Yes

Mode: 9



#### Product Feature

- The product is a constant voltage type controller, working voltage DC12-24V.
- The product is software Bus-based, when all DIP switch is “0”, the address is “1”, could set channel address through the DIP switch as well.
- Diagnostic signal indicator: When DMX sync signal is normal, the signal indicator light fast flash, otherwise it will be off ( can check the problem : bad connection; wire connect sequence error; input and output confusion, etc.).
- With Power off memory function, each time power it, the last power-down mode will be retained.
- When used alone as a controller, with 9 modes, which could be changed by DIP switch on controller, speed could be adjusted through DIP switch when static mode; multiple decoders and LED could be synchronized controlled.
- To achieve more lighting synchronization in same area with the DMX decoder, could connect UltraLux RGB signal amplifier to expand power.

## Interface Specifications

### DMX Input, Output Interface



Standard XLR-3 Caron socket

### Network Interface

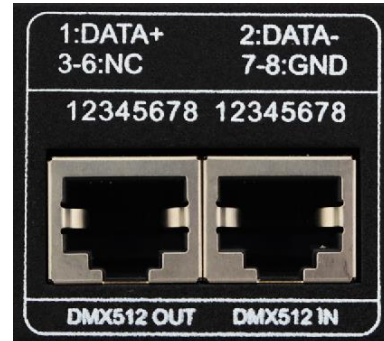

Standard cable RJ45 port

### Address code and Function setting Interface

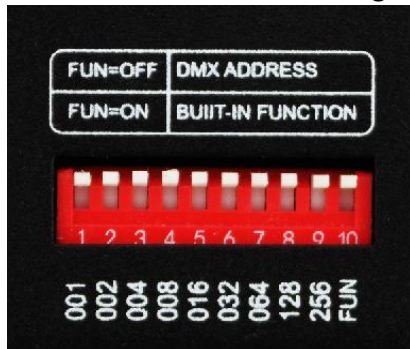

Adopt 10 bit site dial type DIP switch

### Power and load Interface

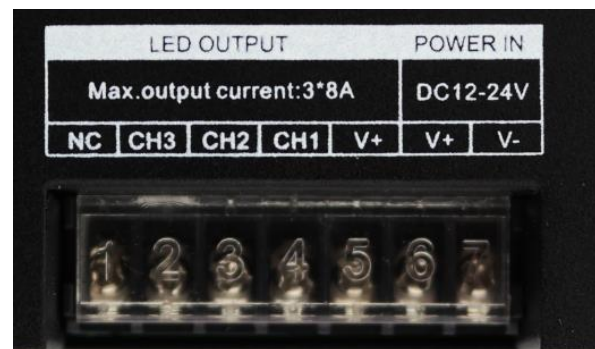

Adopt black column type terminal (with cap)

## Use Instruction

**This product compliance standard DMX 512 protocol, software bus-based set address manually;**

Each DMX512 decoder occupies 3 DMX addresses, adopt DIP switch to set up address: When set up the address via DIP switch, the 10th DIP switch bit is "off" status, and other 9 DIP switches(1-9) bits are binary value code switch, which are used to set up the DMX starting address code. The first DIP switch's bit is the lowest order bit, and the ninth's is the highest order bit. That can set up 511 address codes. The DMX starting address code = (equal to ) sum of 1st to 9<sup>th</sup> bit. If move down the DIP switch ("ON" set as "1"), you can get the bit value of this DIP switch. If move up (set as "0"), the bit value is 0. For example: if you want to set up DMX starting address code for 73, you should move down the 7th, 4th, and 1st DIP switch as "1", and others as "0", Then the bit value sum of 1st to 9th is 64+8+1. That is to say, the DMX512 starting address code is 73.

Select Channel by DIP Switch:

Decimals	1	2	3	4	5	6	7	8	9	10
Weightnumber	1	2	4	8	16	32	64	128	256	FUN

**Example 1:**

Like figure 1, to set up the DMX starting address code for 37, should move down the 6th, 3rd, 1st DIP switch as “1”, others as “0”. Then the bit value sum of 1st to 9th DIP switch is 32+4+1, as is for 37.

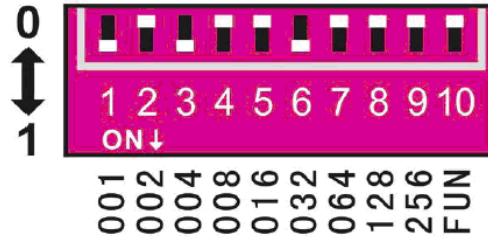

**Example 2:**

Like figure 2, to set up the DMX starting address code for 328, should move down the 9th, 7th, 4th DIP switch as “1”, others as “0”. Then the bit value sum of 1st to 9th DIP switch is 256+64+8, as is for 328.

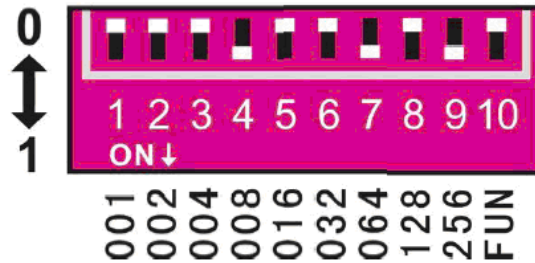

**Other function use Instruction**

**1. Function Test:**

The 10th DIP switch is “FUN”, for built-in function key. When “FUN”=“OFF”(up as 0), this product is for DMX decoder function, which adopt DMX signal; **When “FUN”=“ON”(down as 1), this product is for master controller, which send the operating mode DMX signal to next decoder, so as to achieve multiple decoders synchronized controlled.**

1—9 Switch OFF : all lights are off

- Switch 1=ON: Red
- Switch 2=ON: Green
- Switch 3=ON: Blue
- Switch 4=ON: Yellow
- Switch 5=ON: Purple
- Switch 6=ON: Cyan
- Switch 7=ON: White

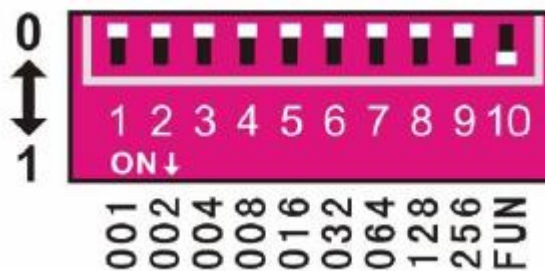

Switch 8=ON : Seven-color jumpy changing (8 grades of speeds are available)

Switch 9=ON: All-color gradual changing (8 grades of speeds are available)

**2. Speed choice of jumpy changing and gradual changing’s effect:**

When test function, switch 8=ON(down as 1), is for seven-color jumpy changing effect. When switch 9=ON, is for seven-color gradual changing effect. 8 grades of speeds are available for each effect:

- 1—7 Switch OFF: 0 grades of speeds
- Switch 1=ON: 1 grades of speeds
- Switch 2=ON: 2 grades of speeds
- Switch 3=ON: 3 grades of speeds
- Switch 4=ON: 4 grades of speeds
- Switch 5=ON: 5 grades of speeds
- Switch 6=ON: 6 grades of speeds
- Switch 7=ON: 7 grades of speeds (Fast speed)

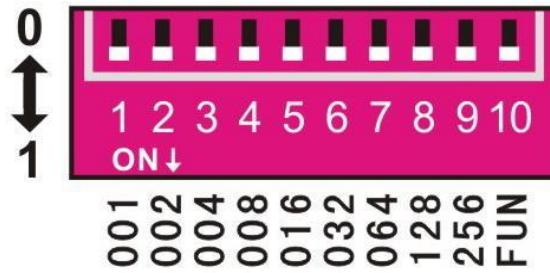

When all switches are “ON” (down as 1) at the same time, the largest value bit is taken as final. That state of decoder is: All-color gradual changing, 7 grades of speeds changing. In addition, when signal indicator (green) blinks slowly, it runs the built-in program effectiveness of decoder. When signal indicator flash rapidly, the decoder receives the DMX signal.

## Typical Applications

### Application 1: (Connection with DMX Console/ DMX Controller)

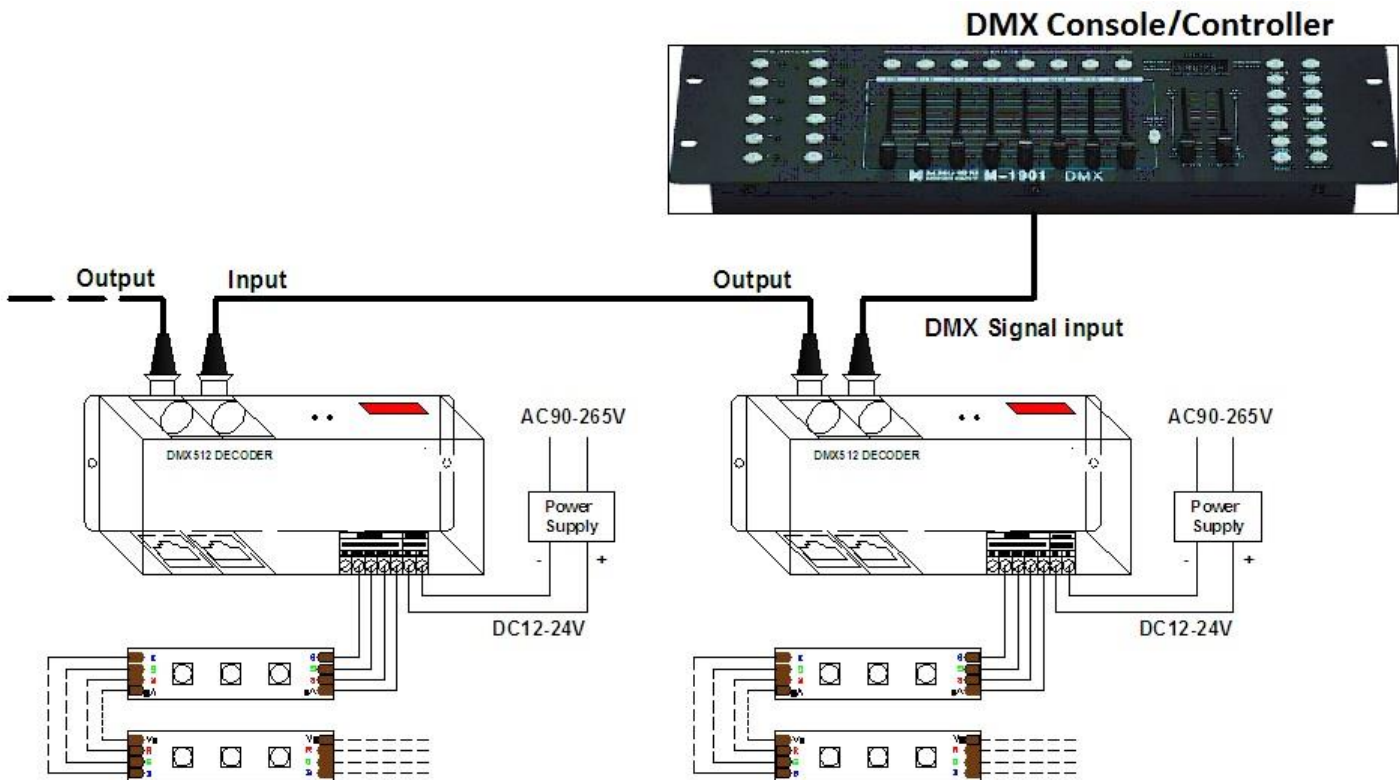

## Application 2 : (Connect with PC)

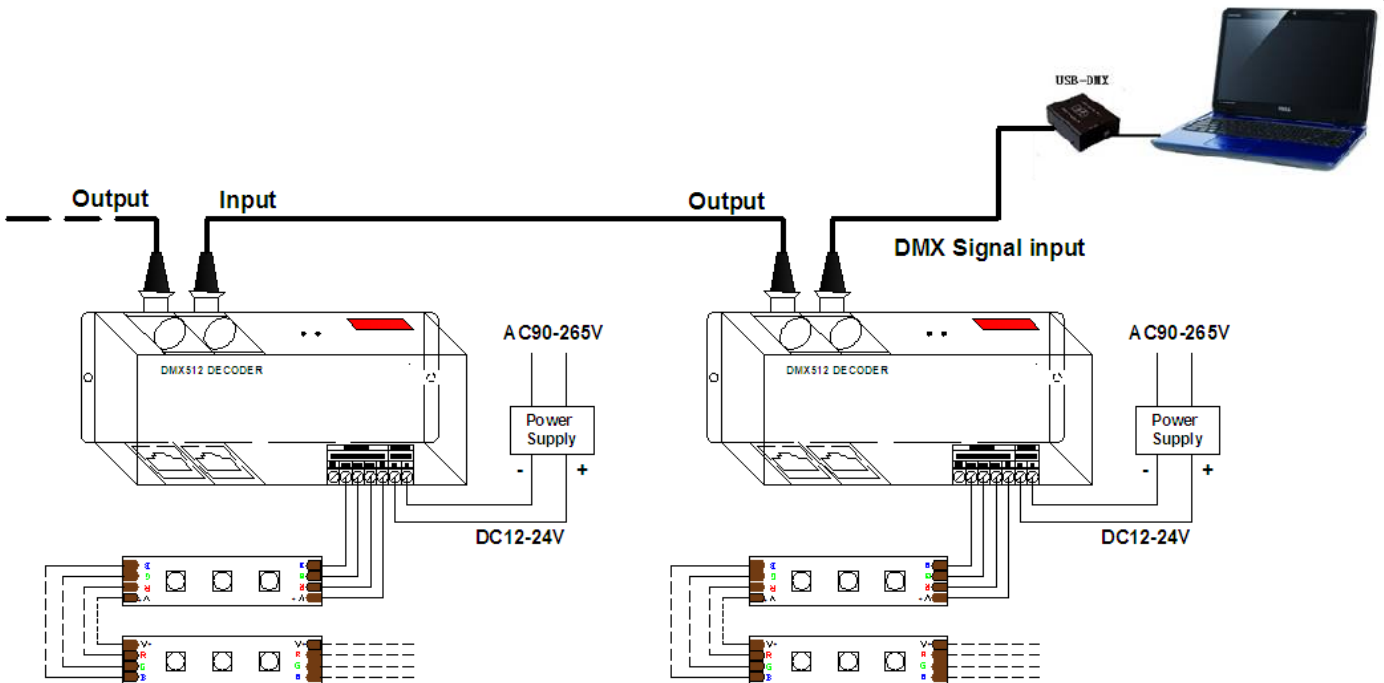

## Application 3 : (Multiple online synchronization)

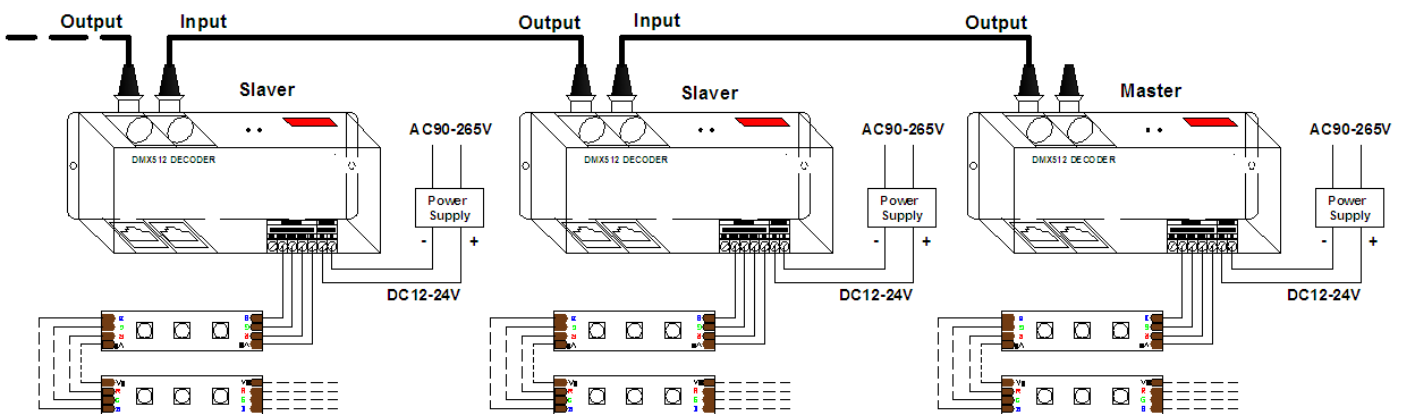

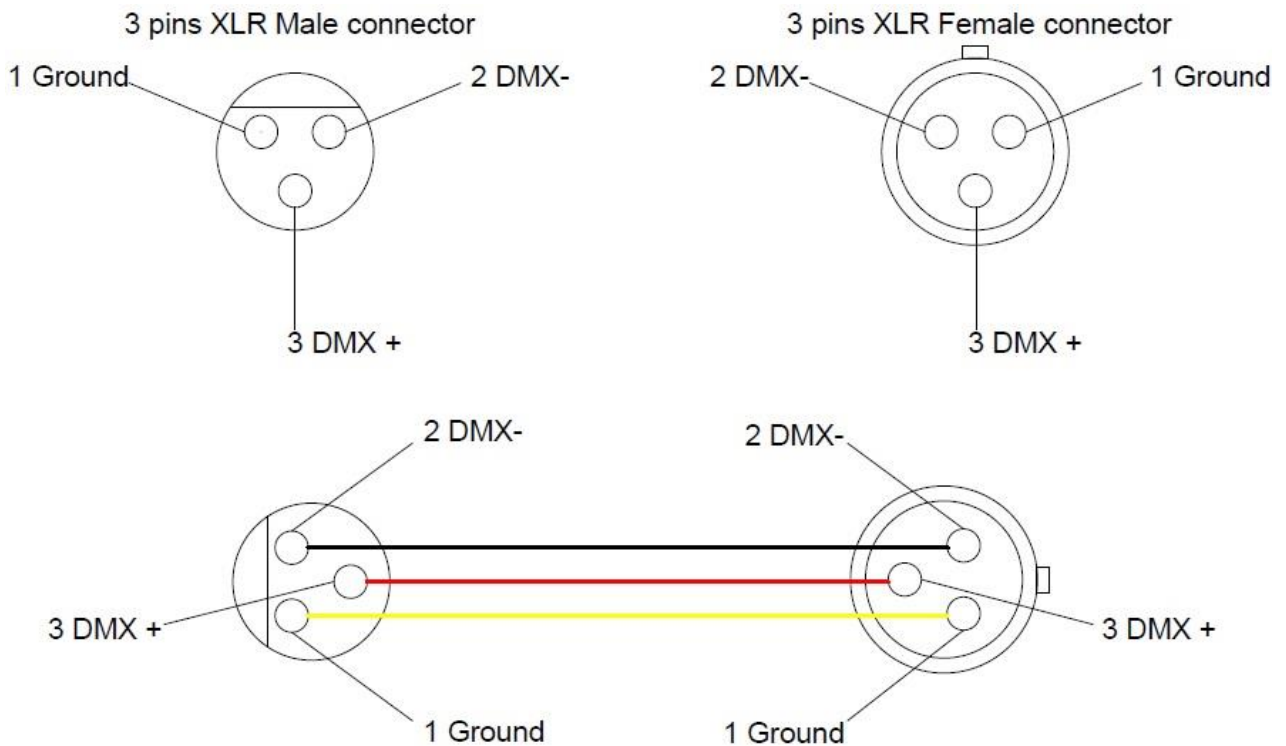

**Notice**

- This product supply voltage is DC 12V÷24V, don't connect to other voltage.
- The lead wire should be properly connected according to the connection diagram.
- Overload may destroy the product, please avoid overload.

**PROBLEMS AND TROUBLESHOOTING**

Problem	Possible reason	Solution
1. Light off after power on	Bad connection with power supply or no output power from power supply	Connect wire with power supply well or change power supply
	Power supply line not connect well or short circuit	Connect power supply wire line well
2. Not work after connecting some loads	Overload and burn out some components of controller	Change the component or change controller
3. Synchronization not work after one of controllers	Signal line loose	Reconnect signal line